



# ASSEMBLY INSTRUCTIONS

## Commercial Island/Aisle Rack

WRAAR1600, WRAAR2000, WRA2400 - Pine  
 WRAAR1601, WRAAR2001, WRA2401 - Redwood

Questions?  
 Toll free 1-888-373-6057 or visit [WineRacksAmerica.com](http://WineRacksAmerica.com)



Thank you and CONGRATULATIONS for purchasing this quality product. Properly assembled, your racking will beautifully enhance your wine collection for many years to come. To assemble, please check to ensure all necessary parts are included and follow the assembly instructions closely. If you have any questions or problems please call customer service toll free 1-888-373-6057 Monday through Friday 7:00 am - 5:00pm MST.



**Planning to stain?**  
 For best results we recommend you stain or finish your racking BEFORE assembly.

### Tools For Assembly:

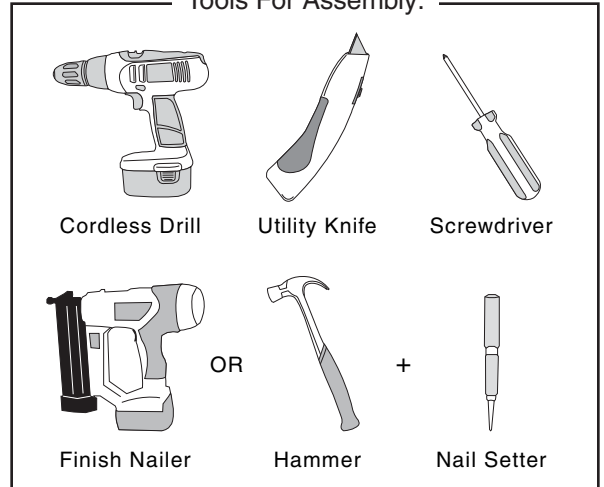

**!** For this product: You will assemble 2 separate racks and place them back to back, then add finish molding.

## PARTS LIST

PARTS ARE NOT TO SCALE

LADDER ASSEMBLY x 22

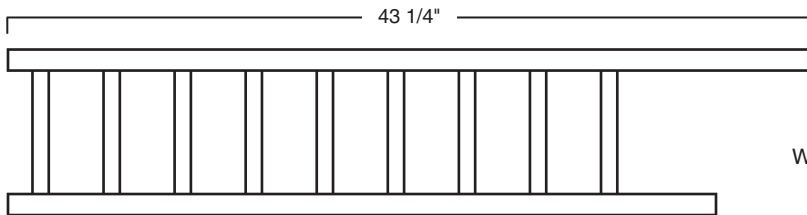

STANDARD COLUMN CONNECTORS

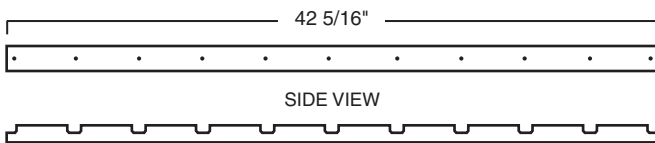

SCREWLESS COLUMN CONNECTORS

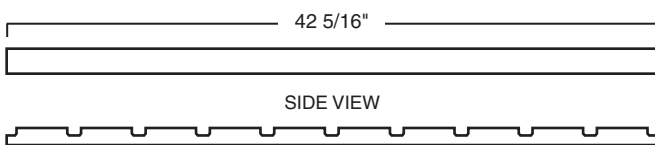

FLOOR MOLDING x 3

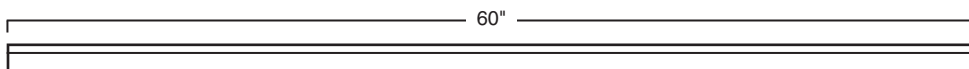

\* The instructions pictured are for the WRAAR200 rack. Follow the same steps for all Island/Aisle Racks, regardless of model.

WOOD DISPLAY TRAYS x 20

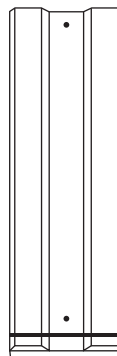

PLEXIGLASS INSERTS x 20

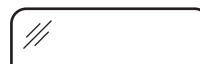

1" WOOD SCREWS x 40



1 1/4" WOOD SCREWS x 66



FINISH NAILS x 22

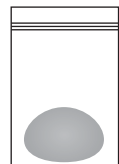

SMALL BAG OF WOOD PUTTY

1. Find an open, flat area in which to work. Carefully remove all components from the box and remove banding with a utility knife. Check the parts list to verify package contents

2. Arrange the two side ladders on the floor so that the bottle support pieces face one another. There is a specific front and back. The end with the staggered risers is the top of your rack, the longer riser is the back of your rack. Attach two standard column connectors to the back of your rack. Secure the connectors at all four corners, using the 1 1/4" screws provided. Make sure that the connectors are flush with the top and bottom edge of the ladders. (figure 1)

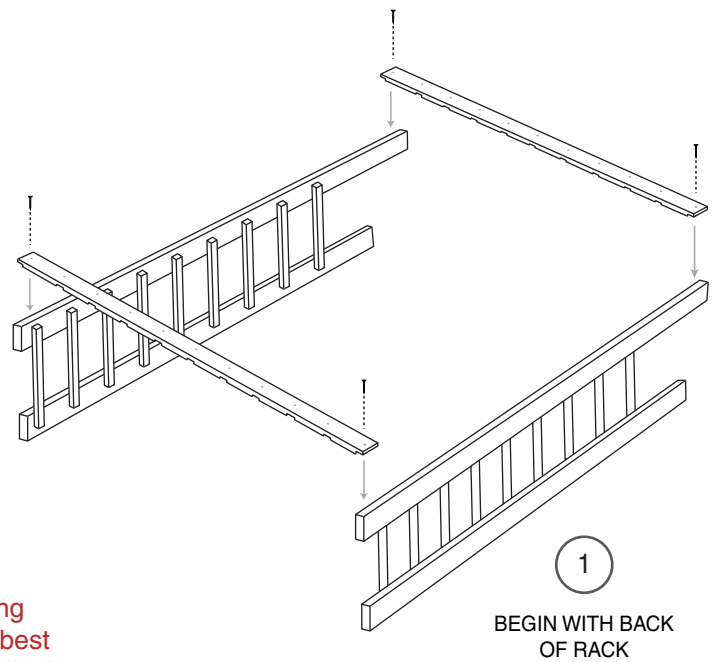

\* Minimize the risk of splitting your side ladders by drilling a 1/16" pilot hole before driving the wood screws. For best results, drive the screw most of the way in with your drill, then finish tightening by hand.

3. Insert middle ladders and finish securing the top and bottom connectors using the 1 1/4" screws provided. **This will be the back of your rack.** (figure 2)

4. Flip rack over and secure one standard column connector at the bottom front of your rack using the 1 1/4" screws provided.

5. Attach one screwless column connector so that the top edge of the connector is flush with the top edge of the riser on the front of the rack. Make sure the rack is flat on the floor while attaching the screwless connectors. (figure 3)

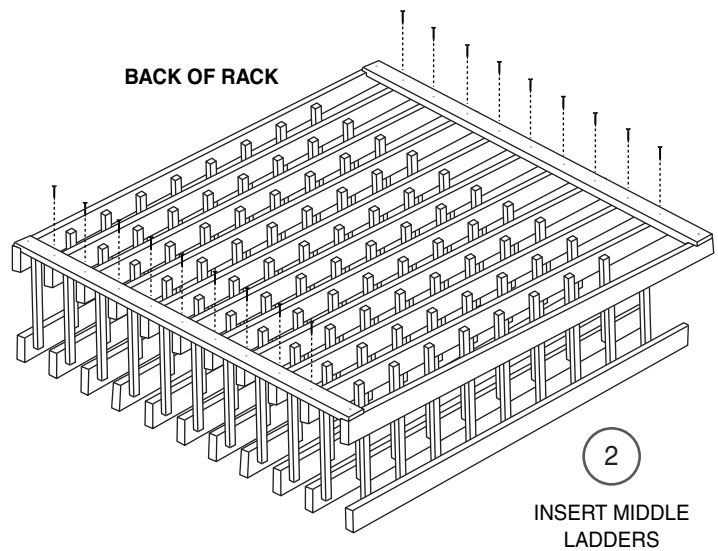

Secure the screwless connector using a finish nail gun to drive a finish nail through the connector into each vertical ladder. (figure 4)

If you do not have a finish nail gun, drive one of the provided finish nails into each vertical ladder until it is flush. Then, countersink the nail using a nail setter until the head of the nail is about 1/16" below the surface of the wood.

6. Fill the nail holes using the wood putty provided. Simply push the putty into each hole using your thumb and wipe excess putty off the surface using a damp cloth.

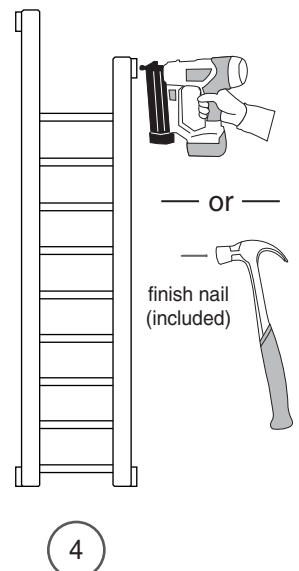
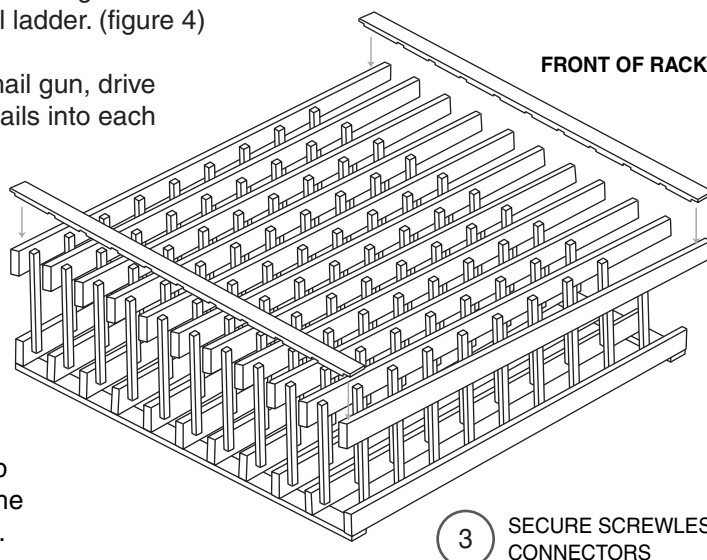

## 7. Insert Display Shelves

Stand your rack and attach the display shelves so that the notches on each shelf sit on the upper connectors of the rack. Secure each shelf with two 1" wood screws. (figure 5)

Insert a plexiglass bottle stopper into the slot of each display shelf. If you wish, use a glue gun or a dab of epoxy to secure the plexiglass holder into its slot. (figure 6)

SECURE DISPLAY TRAYS WITH 1" SCREWS  
AND INSERT BOTTLE STOPPERS

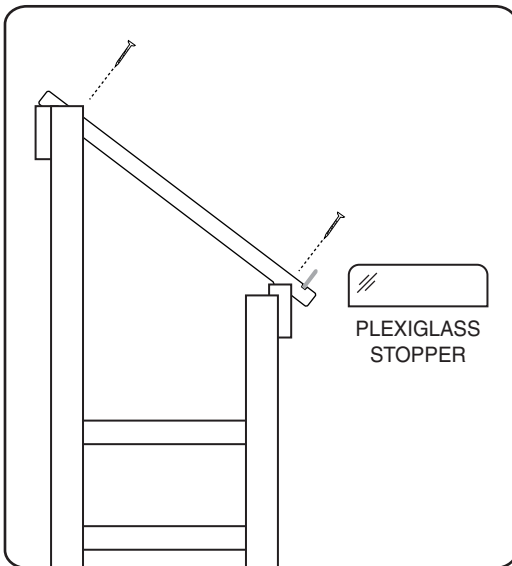

6

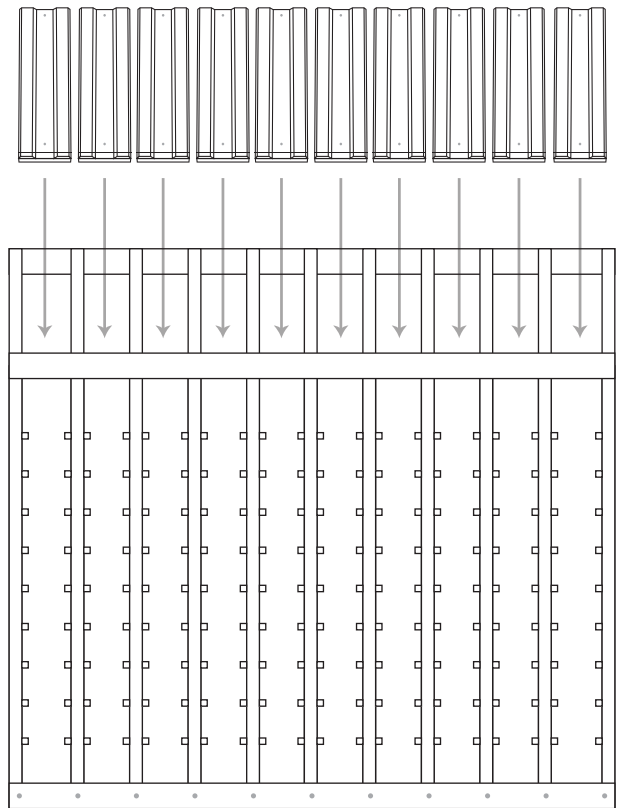

5 ATTACH DISPLAY  
TRAYS

8. Repeat steps 2-7 to assemble the second Display Rack.
9. Align both units back to back so that the horizontal connectors on the back of the racks are touching. (figure 7)

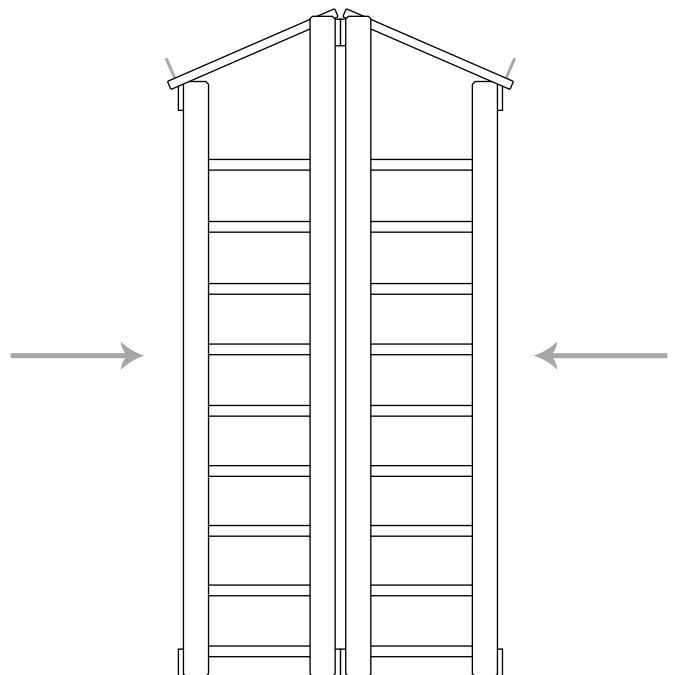

7 ASSEMBLE SECOND RACK AND  
ALIGN RACKS BACK TO BACK

10. Our floor molding installs just like regular finish molding in your house. It will fit directly over the bottom horizontal connector on each rack. (figure 8)

It will be necessary to make a 45° Miter cut in the areas where the front and side molding meet. (figure 9)

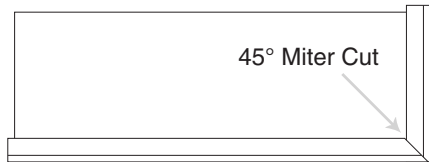

9 MAKE MITER CUTS WHERE NECESSARY

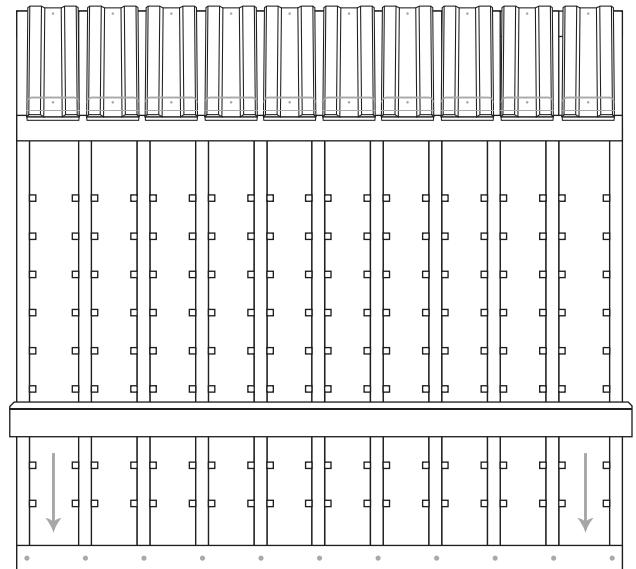

8 ATTACH FLOOR MOLDING

11. Attach floor molding with wood glue or a small finish nail. (figure 10)

Fill the nail holes & overlap joints using the wood putty provided or any quality matching wood filler. Simply push the putty into each hole and overlap joint using your thumb or putty knife. Wipe away excess putty using a damp cloth.

12. That's it! Enjoy this beautiful rack with your favorite beverage. Pair with other rack styles for an ultimate cellar storage look.

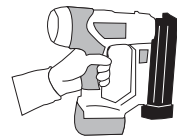
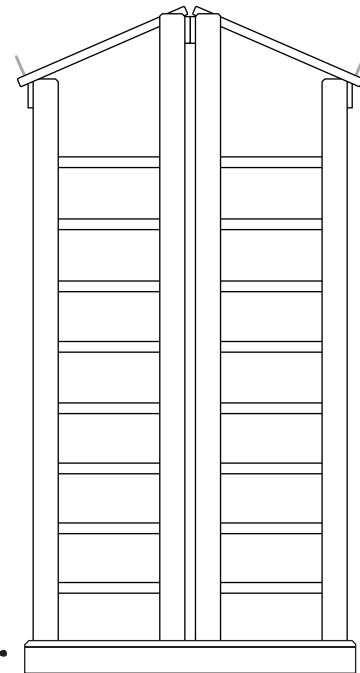

10 SECURE MOLDING WITH FINISH NAILS

 **WINE RACKS AMERICA**

360 N 700 W suite F • North Salt Lake, UT 84054  
 (toll free) 888-373-6057  
 (fax) 801-936-0534

WineRacksAmerica.com

Once again thank you for your business. Remember, customer service is available to answer your questions M-F 7:00 am - 5:00 pm MST. Please feel free to contact us for any wine storage need.