



# ASSEMBLY INSTRUCTIONS

## Decorative Cellar Arch (Small)

WRACA200, WRACA201, WRACA202

Questions?

Toll free 1-888-373-6057 or visit [WineRacksAmerica.com](http://WineRacksAmerica.com)



Thank you and CONGRATULATIONS for purchasing this quality product. Properly assembled, your racking will beautifully enhance your wine collection for many years to come. To assemble, please check to ensure all necessary parts are included and follow the assembly instructions closely. If you have any questions or problems please call customer service toll free 1-888-373-6057 Monday through Friday 7:00 am - 5:00pm MST.



### Planning to stain?

For best results we recommend you stain or finish your racking BEFORE assembly.

### Tools For Assembly:

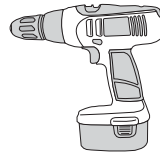

Cordless Drill



Utility Knife

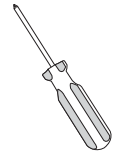

Screwdriver

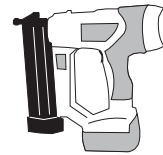

Finish Nailer

OR

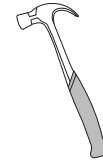

Hammer

+



Nail Setter

## PARTS LIST

RIGHT SIDE ASSEMBLY

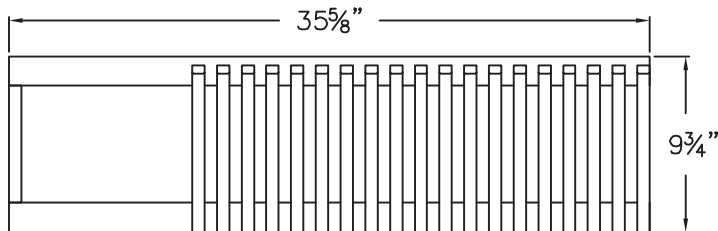

[x8] WOOD SCREWS



[x2] FINISH NAILS

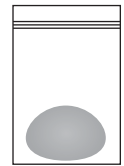

SMALL BAG OF WOOD PUTTY

LEFT SIDE ASSEMBLY

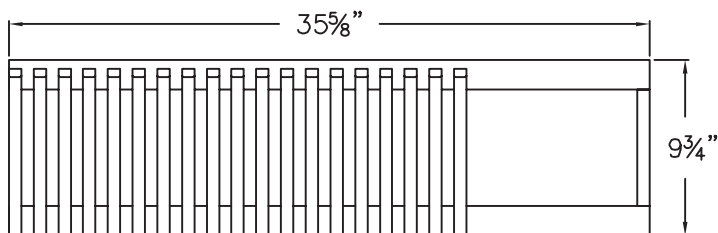

BASE SUPPORT PIECE (optional)

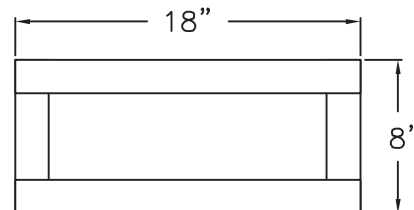

ARCH BODY

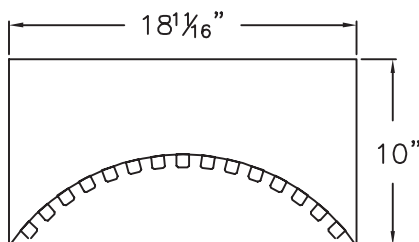

TOP TRIM PIECE

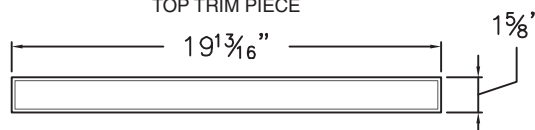

INTERIOR LIGHT BAR

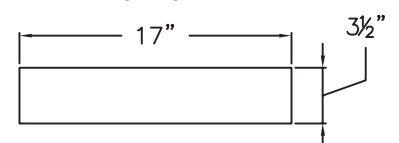

\* PLEASE FOLLOW WRITTEN INSTRUCTIONS CAREFULLY

1. Find an open, flat area in which to work.  
Carefully remove all components from the box and remove banding with a utility knife.  
Check the parts list to verify package contents.
2. Lay the arch flat on the floor or table. Align the top of the right side assembly flush with the top of the arch and align the back edge of the side assembly flush with the back edge of the arch.

Secure the right side assembly using (4) of the provided wood screws. The side assemblies have pre-drilled screw holes. (figure 1)

3. Repeat step 2 to secure the left side assembly. (figure 2)

**\*Minimize the risk of splitting the wood by drilling a 1/16" pilot hole before driving the wood screws. For best results, drive the screw most of the way in with your drill, then finish tightening by hand.**

4. If you plan on using Wine Racks America Top Shelving System it will be necessary to remove the spacer bars on the side assemblies.

Simply tap the bottom of the spacer bar with a hammer in an upward motion towards the top of the side assembly. The spacer bar is secured with two small pin nails and should detach easily. Repeat process for second spacer bar. (figure 3)

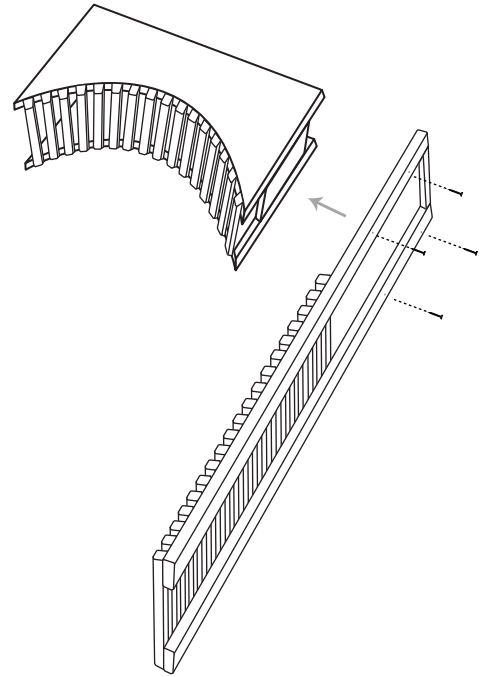

1 ATTACH RIGHT SIDE ASSEMBLY

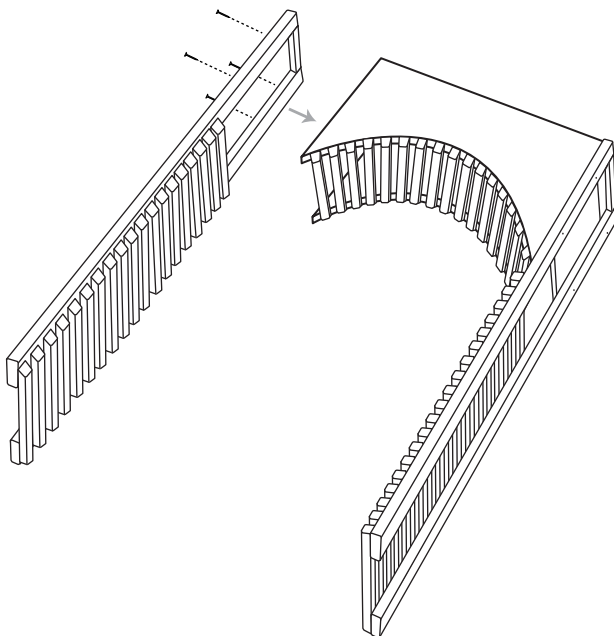

2 ATTACH LEFT SIDE ASSEMBLY

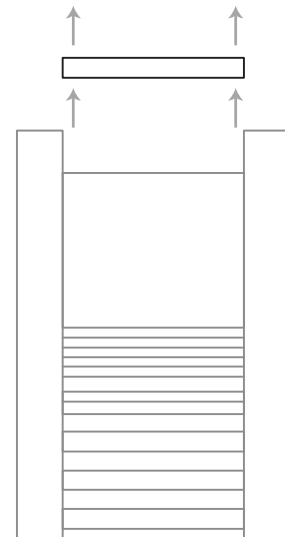

3 REMOVE SPACER BARS

\* PLEASE FOLLOW WRITTEN INSTRUCTIONS CAREFULLY

5. Attach the top trim piece so that the top edge of the trim piece fits flush with the top edge of the arch and side assemblies. **Make sure that the unit is flat on the floor or a table** while attaching the top trim piece. (figure 4)

Secure the top trim piece using a pneumatic finish nailer. Simply drive 2 finish nails (one at each end) through the top trim piece securing it to each side assembly. (figure 5)

If you do not have a pneumatic finish nailer, drive one of the provided finish nails through each end of the top trim piece into the side assemblies until it is flush. Then, countersink the nail using a nail setter until the head of the nail is about 1/16" below the surface of the wood.

6. Fill the nail holes using the wood putty provided. Simply push the putty into each hole using your thumb and wipe excess putty off the surface using a damp cloth.

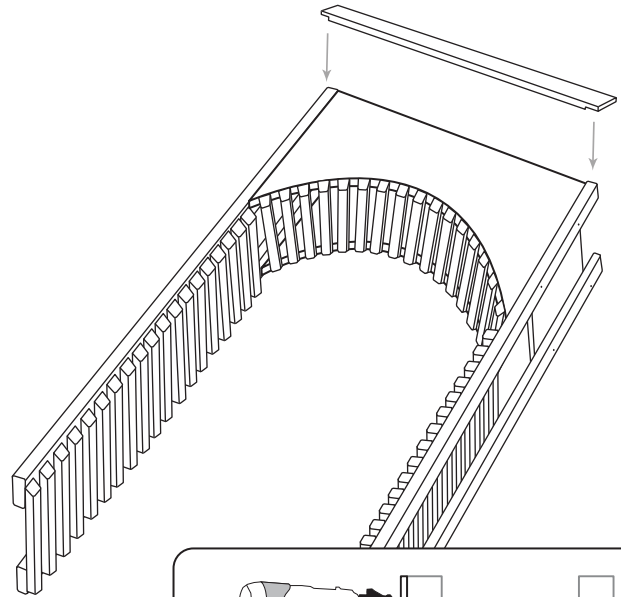

4 ATTACH TOP TRIM PIECE

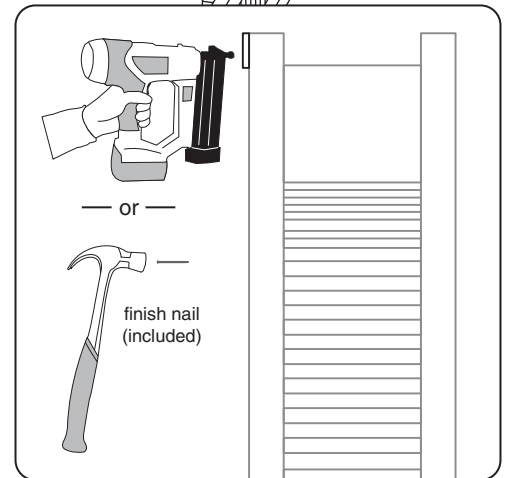

5 SECURE WITH FINISH NAILS

7. The Wine Racks America Cellar Arch comes pre-configured to accommodate most cabinet lighting. Simply attach lights to the interior light bar and set it down into place through the top of the arch.

Two of the most popular lighting styles are puck lights (example A), and LED lighting (example B).

**note:** Some lighting styles will require you to drill holes in the light bar using a hole saw or drill bit.

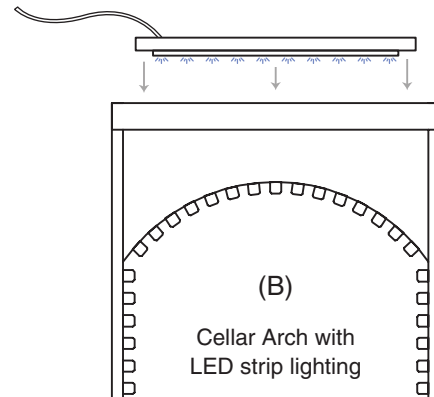
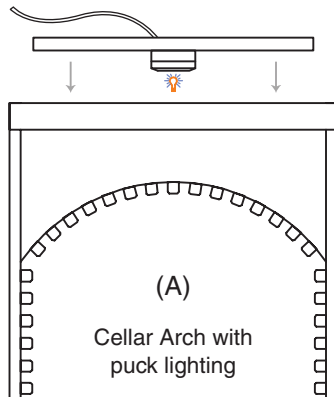

\* PLEASE FOLLOW WRITTEN INSTRUCTIONS CAREFULLY

8. Stand up your arch and lift it into place. The Wine Racks America Small Cellar Arch is designed to be installed above our 48 bottle Wine Cube Collection.

When using the Small Cellar Arch with other full height modular racks it will be necessary to use the Base Support Piece. Simply place it under your 48 bottle Wine Cube Collection to make the top of your arch flush with the tops of the other racking (figure 6). This will also lift your cube off the floor for easier base molding installation (figure 7).

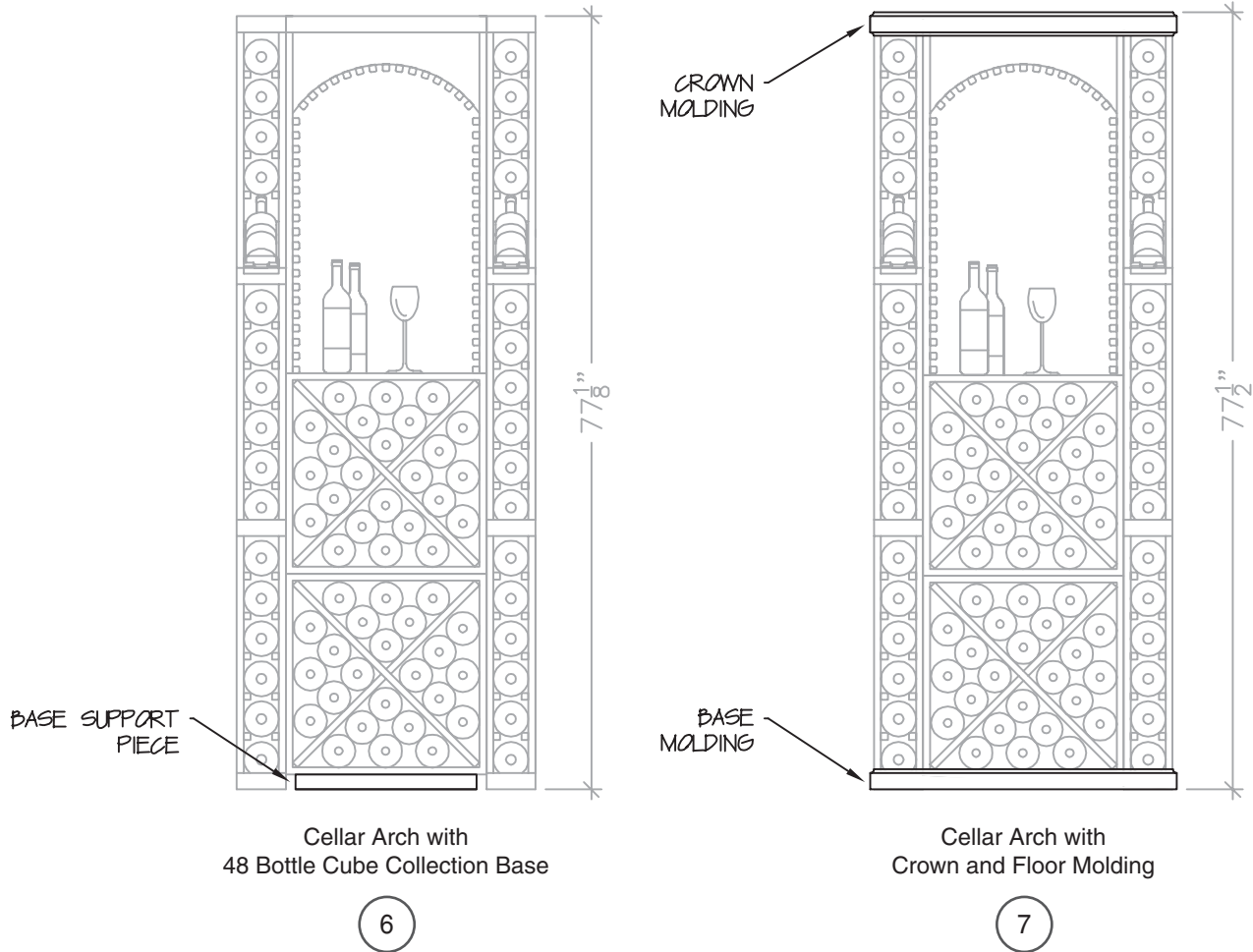

9. That's it! Enjoy this beautiful product with your favorite beverage. Pair with other rack styles for an ultimate cellar storage look.



**WINE RACKS AMERICA**

360 N 700 W suite F • North Salt Lake, UT 84054  
(toll free) 888-373-6057  
(fax) 801-936-0534

WineRacksAmerica.com

Once again thank you for your business. Remember, customer service is available to answer your questions M-F 7:00 am - 5:00 pm MST. Please feel free to contact us for any wine storage need.